

# KVADRO-100 / KVADRO-125

## Frameless ventilation diffuser

### Technical specification

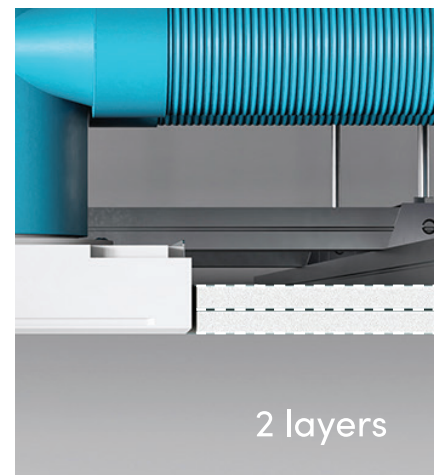
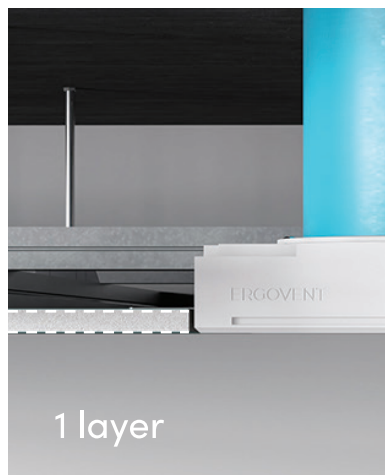
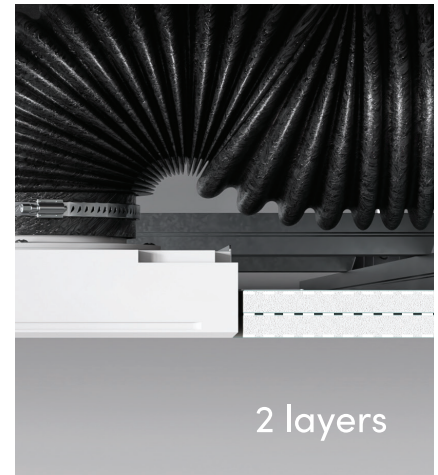
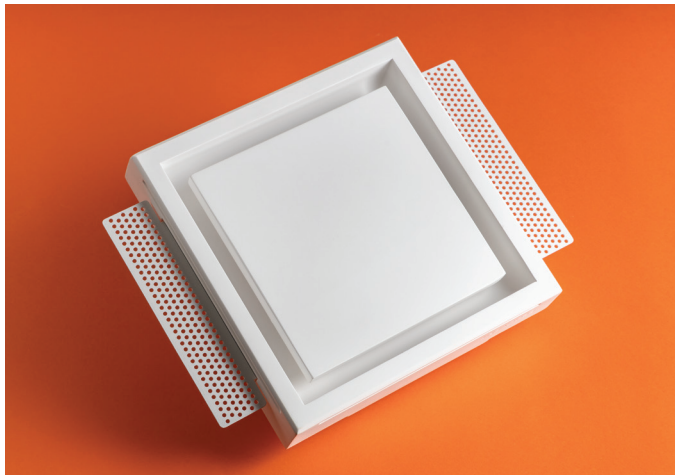
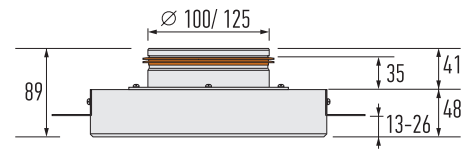
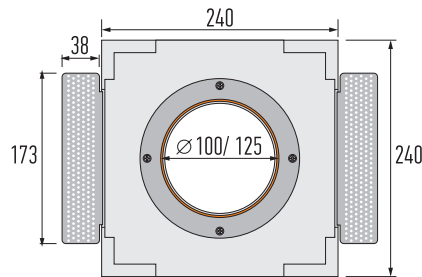
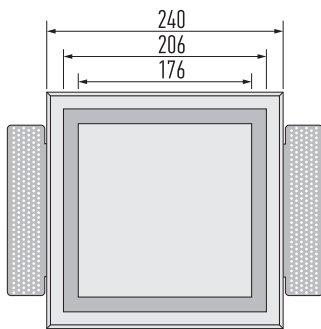

# KVADRO-100 / 125

## Technical data



frameless  
air diffusers

KVADRO 100 (supply air)

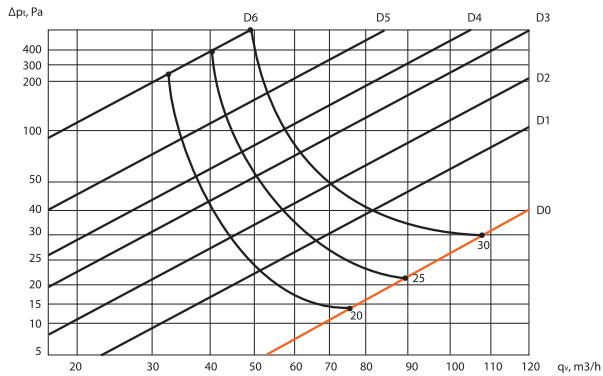

KVADRO 125 (supply air)

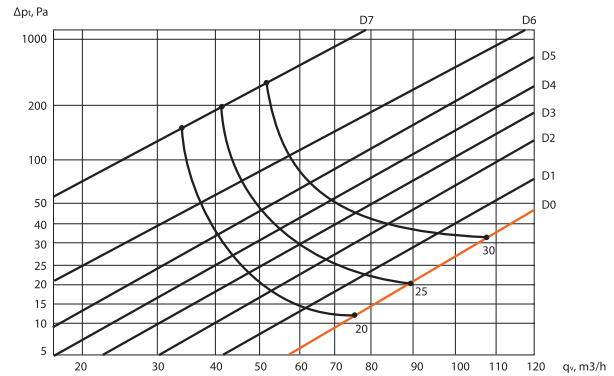

KVADRO 100 (exhaust air)

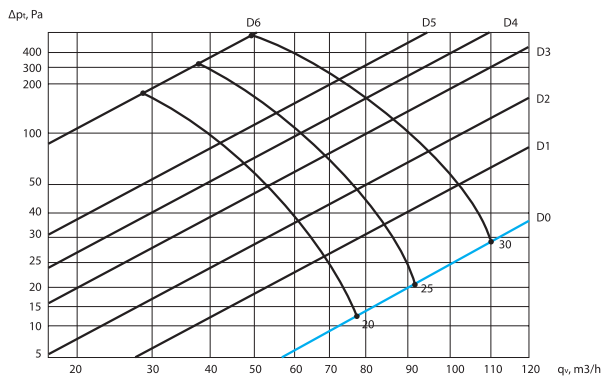

KVADRO 125 (exhaust air)

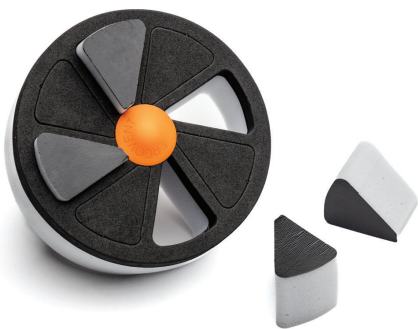
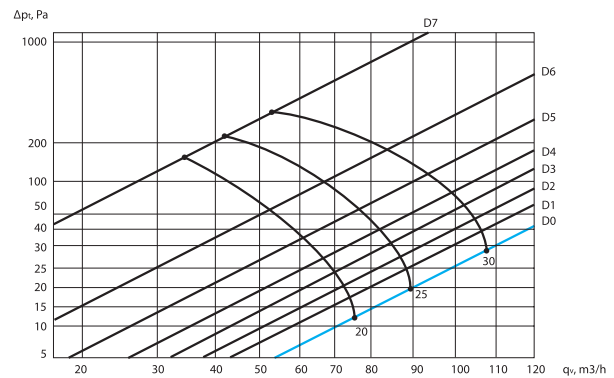

Polyurethane dampers are used to adjust the airflow.

- D0 – no damper inserted
- D1 – 1 segment inserted
- D2 – 2 segments inserted
- D3 – 3 segments inserted
- D4 – 4 segments inserted
- D5 – 5 segments inserted
- D6 – 6 segments inserted
- D7 – 7 segments inserted

KVADRO 100/125  
velocity, m/s

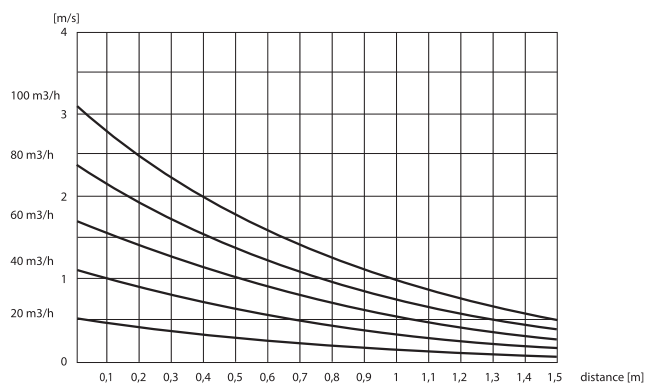

Scan QR code to download the installation instructions.